

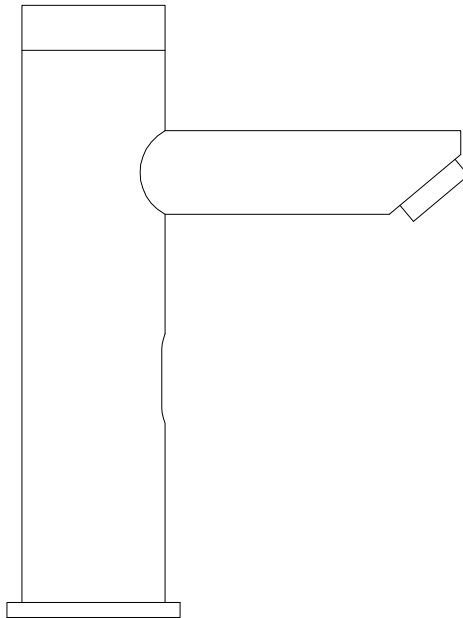

# **INSTALLATION INSTRUCTIONS**

## **ELITE BENCH MOUNTED SENSOR TAP**

### **ET2-30.5**



**Thank you for purchasing this Enviro-Tech product**



# INSTALLATION INSTRUCTIONS ELITE TAPWARE BENCH MOUNTED

We strongly recommend that you use a qualified and registered plumber and electrician. You must ensure that all pipe work is flushed adequately, particularly in new builds or where lines have been disrupted. Components of sensor taps are particularly susceptible to debris and will require more thorough flushing than a standard plumbing fixture. Failure to flush lines adequately will result in blocked or leaking valves (check/solenoid) or a dripping tap soon after installation and is not covered by the Enviro-Tech warranty.

## TECHNICAL SPECIFICATION

Function	Elite Tapware Bench Mounted
Power Input	DC: 6V (4X1.5V AA alkaline batteries) AC:220-240V (50/60Hz)
Power Consumption	<0.3MW
Power Supply	4 AA alkaline batteries or transformer
Water Pressure	100kPa-500kPa
Inlet/outlet Diameter	15mm 1/2G
Detection Zone	Self adjusting
Confirmation Time	1 second

## TAP PARTS

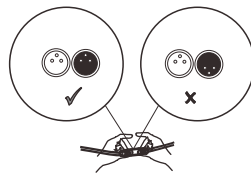
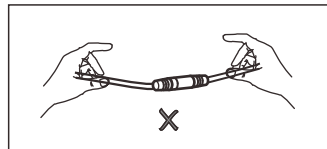
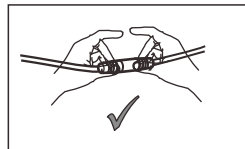
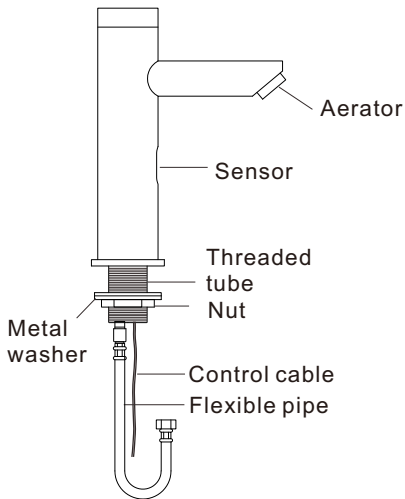

**Attention:**  
Hold the plug not the wire to connect and disconnect and make sure the pins align to the holes in the right position.

## BATTERY INSTALLATION

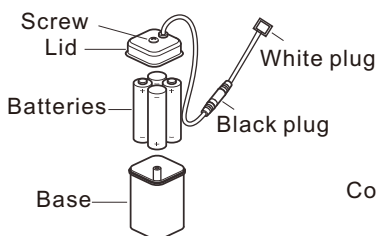

**WARNING:**  
Carefully unplug the black battery plugs, if the battery box cable is pulled the main power white plug can be pulled out from the control box. This will result in the control box not functioning.

## CONTROL BOX PARTS

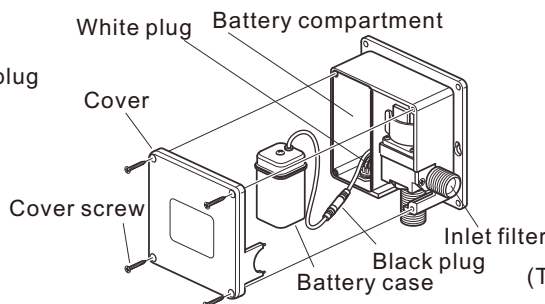

## TRANSFORMER

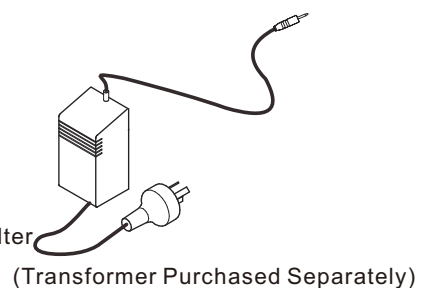

1

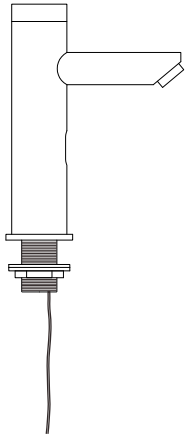

2

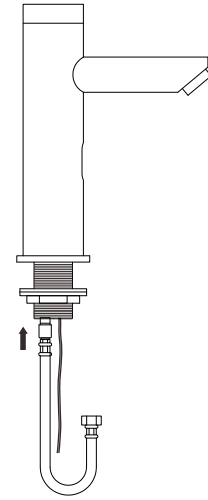

Screw the flexihose on to the bottom of the threaded tube, hand tighten only.

3

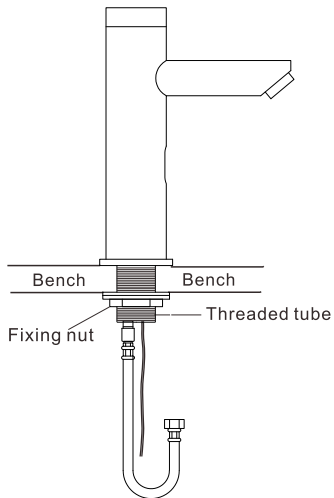

Tighten the fixing nut to secure tap to bench top (do not over tighten as this may damage bench top) Do not tighten the threaded tube.

4

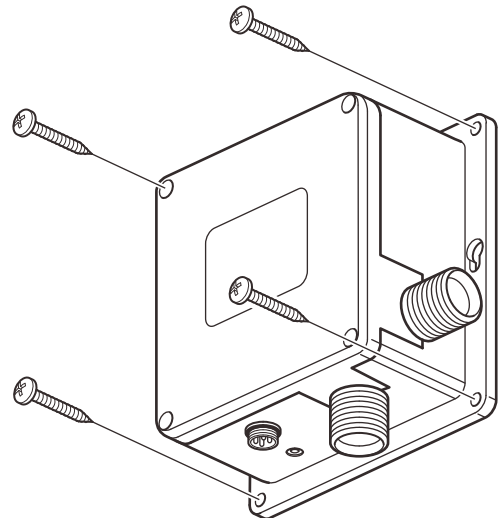

Screw control box in a suitable position under the basin making sure flexihose and control cable can reach.

5

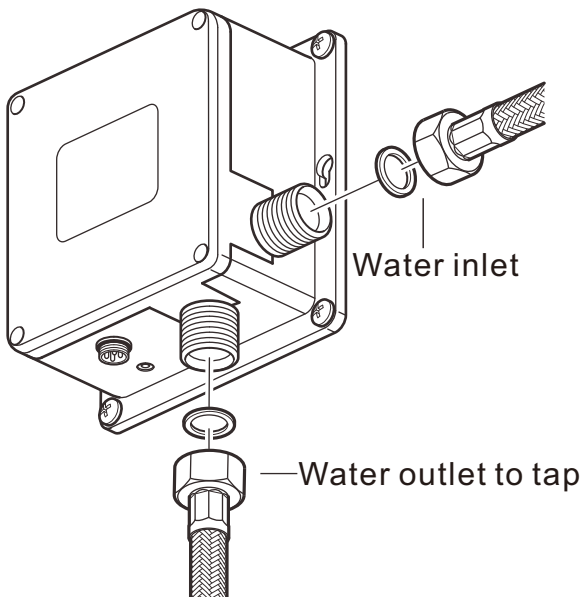

Make sure that the rubber washers are in place in the flexihoses.

6

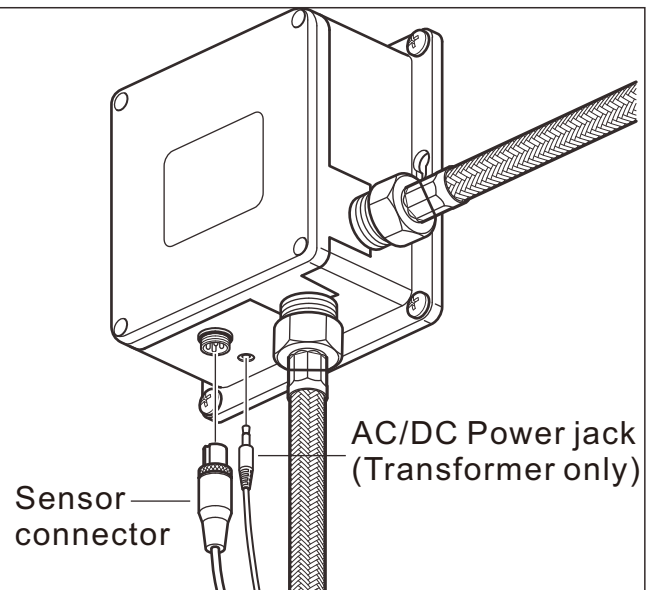

Hold the plug not the wire to connect and disconnect.

# TROUBLE SHOOTING

Problem	Possible Cause	Solution
No water out or water will not turn off	Most common: No water supply/No Power  Sensor obstructed	<ul style="list-style-type: none"><li>• Check water and power supply, change batteries.</li><li>• Unplug all cables, leave unplugged for 5 minutes and reconnect everything carefully.</li></ul> Clean sensor
Too little water flow	Low water pressure/pressure is turned down The filter or solenoid is dirty	Adjust/raise the pressure  Clean the filter. Clean/replace solenoid
Too much water flow	Water pressure is too high	Adjust pressure
Indicator light is off/flashing	Batteries are flat Bad connection	Replace batteries Check connections
Tap is self-activating	All infra-red technology can be affected by strong or directional light, reflective surfaces or high-viz clothing. This is due to environmental factors and is not a product fault.	

**For detailed troubleshooting advice, see the Installation page of our websites [enviro-tech.com.au](http://enviro-tech.com.au) or [enviro-tech.co.nz](http://enviro-tech.co.nz) or call us on the numbers below.**



## WARRANTY

Enviro-Tech warrants that all tap bodies and standard chrome finish be guaranteed for 5 years from the date of purchase. All non-standard finishes are guaranteed for 2 years from the date of purchase with a 12 month repair or replacement warranty on all other products and parts. For full details of the warranty conditions, see the Warranty page of our websites.

## AFTERCARE

Whilst advanced plating techniques are used in the manufacture of this product. The surface will be affected if cleaned incorrectly. Surfaces should be maintained using a clean damp cloth, no abrasive agents or materials should be used or come into contact with the surface finish, or this will invalidate your warranty.

This Enviro-Tech product is manufactured strictly to adhere to the ISO9001 standard, WaterMark certification and WELS standards. Enviro-tech reserves the right to update product technology at any time.

### Contact Info:

Australia – 1300 530 883 or [info@enviro-tech.com.au](mailto:info@enviro-tech.com.au)

New Zealand – 0800 2 ENVIRO or [info@enviro-tech.co.nz](mailto:info@enviro-tech.co.nz)