



Enviro-Tech

INSTALLATION INSTRUCTIONS

ELITE BENCH MOUNTED SENSOR TAP

ET2-56

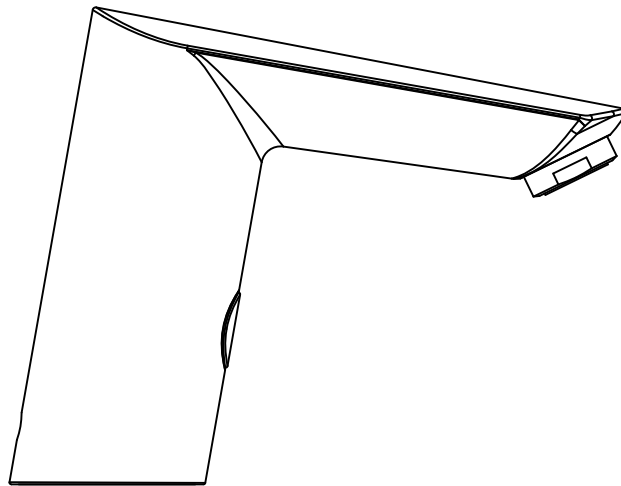

Thank you for purchasing this Enviro-Tech product



INSTALLATION INSTRUCTIONS ELITE TAPWARE BENCH MOUNTED

We strongly recommend that you use a qualified and registered plumber and electrician. You must ensure that all pipe work is flushed adequately, particularly in new builds or where lines have been disrupted. Components of sensor taps are particularly susceptible to debris and will require more thorough flushing than a standard plumbing fixture. Failure to flush lines adequately will result in blocked or leaking valves (check/solenoid) or a dripping tap soon after installation and is not covered by the Enviro-Tech warranty.

TECHNICAL SPECIFICATION

Function	Elite Tapware Bench Mounted
Power Input	DC: 6V (4X1.5V AA alkaline batteries) AC:220-240V (50/60Hz)
Power Consumption	<0.3MW
Power Supply	4 AA alkaline batteries or transformer
Water Pressure	100kPa-500kPa
Inlet/outlet Diameter	15mm 1/2G
Detection Zone	Self adjusting
Scald Prevention	5% cold water feeds in to the hot feed for safety purposes
Confirmation Time	1 second

TAP PARTS

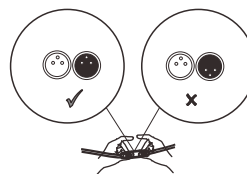
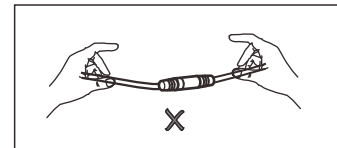
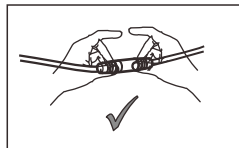
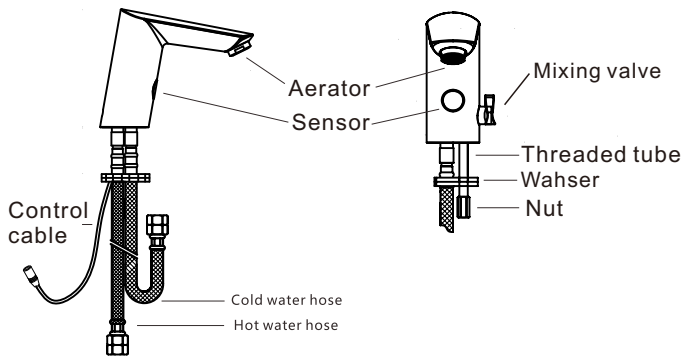

Attention:
Hold the plug not the wire to connect and disconnect and make sure the pins align to the holes in the right position.

BATTERY INSTALLATION

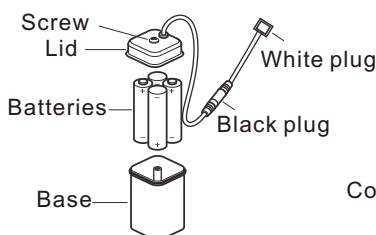

CONTROL BOX PARTS

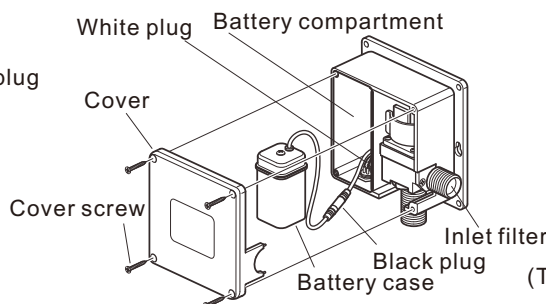

TRANSFORMER

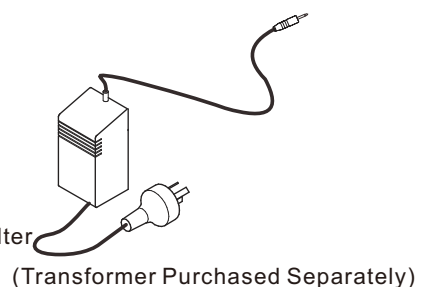

WARNING:
Carefully unplug the black battery plugs, if the battery box cable is pulled the main power white plug can be pulled out from the control box. This will result in the control box not functioning.

1

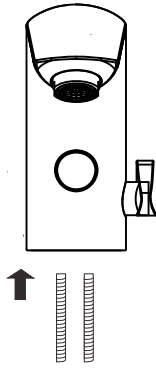

Screw in fixing threads.

2

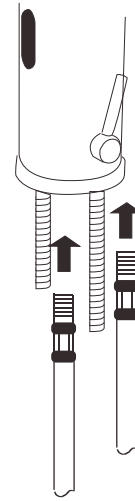

Connect flexi hoses to tap.

3

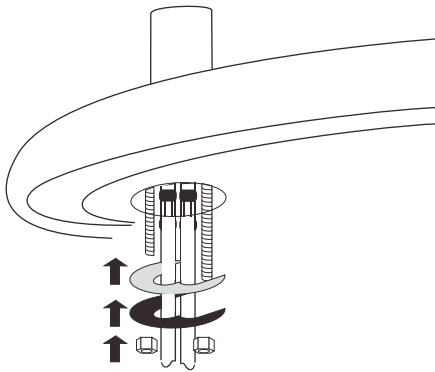

Place through hole in basin/bench. Secure to basin/bench as shown. (Do not over tighten as this may damage basin/bench top)

4

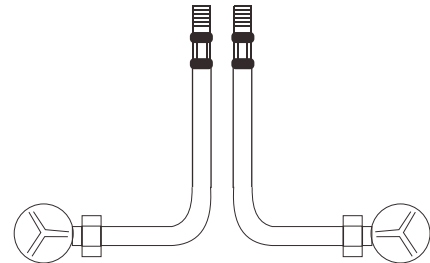

Connect correct flexi hoses (as marked) to hot and cold feeds.

5

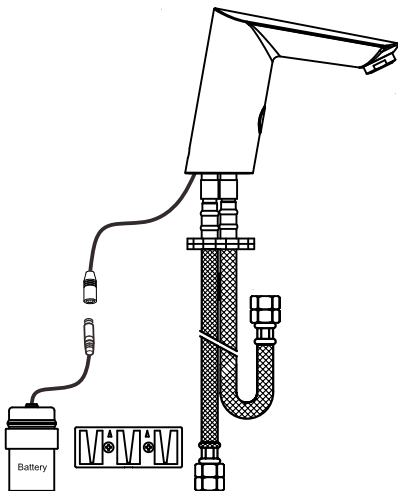

DC Battery Only: Fix bracket to wall and connect battery box to control cable.

6

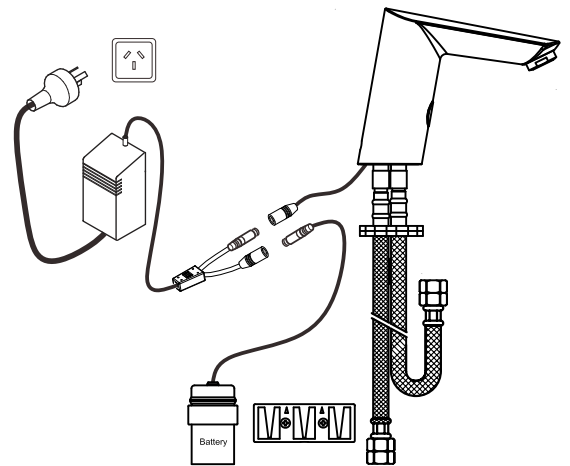

AC/DC Transformer with battery back up: Fix bracket to wall and connect battery box to transformer plug then connect other transformer plug to tap control cable. Plug into socket.

TROUBLE SHOOTING

Problem	Possible Cause	Solution
No water out or water will not turn off	Most common: No water supply/No Power Water pressure too low Blocked filter Sensor obstructed	<ul style="list-style-type: none"> • Check water and power supply, change batteries. • Unplug <u>all</u> cables, leave unplugged for 5 minutes and reconnect everything carefully. Raise water pressure Clean filter Clean sensor
Too little water flow	Low water pressure The filter or solenoid is dirty	Adjust/raise the pressure Clean the filter. Clean/replace solenoid
Too much water flow	Water pressure is too high	Adjust pressure
Water is too cold	Hot water supply has been tempered.	This tap feeds 5% cold water automatically into the hot feed as a safety feature. If your hot water feed has already been tempered, the water at the spout will be cooler than your tempered supply. You may need to turn up your hot water temperature to achieve the desired user temperature.
Indicator light is off/flashing	Batteries are flat Bad connection	Replace batteries Check connections
Erratic activation on installation	Reflective light – the sensor needs to be reset. (May need to perform the reset more than once)	<ul style="list-style-type: none"> • Unplug tap from power, disconnect from tap end to include battery box and leave for 2-3 minutes. • Reconnect all plugs carefully to restore power. • Hold your hand 150mm from the sensor window for a full 60 seconds to allow sensor to reset itself. • If problem persists, contact us for advice on the numbers below.

For detailed troubleshooting advice, see the Installation page of our websites enviro-tech.com.au or enviro-tech.co.nz or call us on the numbers below.



WARRANTY

Enviro-Tech warrants that all tap bodies and standard chrome finish be guaranteed for 5 years from the date of purchase. All non-standard finishes are guaranteed for 2 years from the date of purchase with a 12 month repair or replacement warranty on all other products and parts. For full details of the warranty conditions, see the Warranty page of our websites.

AFTERCARE

Whilst advanced plating techniques are used in the manufacture of this product. The surface will be affected if cleaned incorrectly. Surfaces should be maintained using a clean damp cloth, no abrasive agents or materials should be used or come into contact with the surface finish, or this will invalidate your warranty.

This Enviro-Tech product is manufactured strictly to adhere to the ISO9001 standard, WaterMark certification and WELS standards. Enviro-tech reserves the right to update product technology at any time.

Contact Info:

Australia – 1300 530 883 or info@enviro-tech.com.au

New Zealand – 0800 2 ENVIRO or info@enviro-tech.co.nz