

ET3-M SMART DEMAND URINAL FLUSH VALVE TROUBLE SHOOTING

Issue - No Water Out or Water Running On

- CHECK WATER SUPPLY;
- CHECK POWER SUPPLY – WATER CONSTANTLY RUNNING ON MEANS NOT ENOUGH POWER TO SOLENOID, EITHER POWER SUPPLY ISSUE OR INCORRECT CONNECTIONS. (SEE DIAGRAM BELOW)
- IF URINAL HAS BEEN OPERATING CORRECTLY FOR SOME TIME AND HAS SUDDENLY STOPPED – LIKELY CAUSE IS NO POWER. CHANGE BATTERIES AND CHECK MAINS POWER SUPPLY/HOTPOINT. FLUSH VALVE MUST BE MAINS POWERED WITH BATTERY BACK-UP, IT IS NOT DESIGNED TO RUN ON BATTERY ONLY;
- UNPLUG ALL CABLES, LEAVE UNPLUGGED FOR 5 MINUTES (THIS GIVES THE ELECTRONICS A CHANCE TO RESET) BEFORE RECONNECTING EVERYTHING CAREFULLY IN THE CORRECT ORDER (SEE DIAGRAM BELOW) **WARNING– ELECTRONICS WILL BE DAMAGED IF CONNECTED INCORRECTLY;**

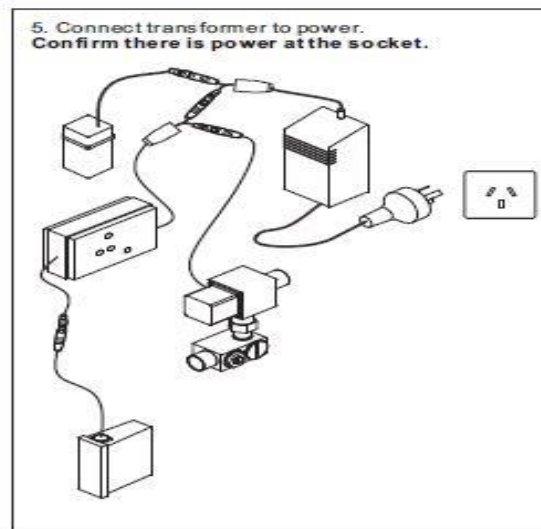
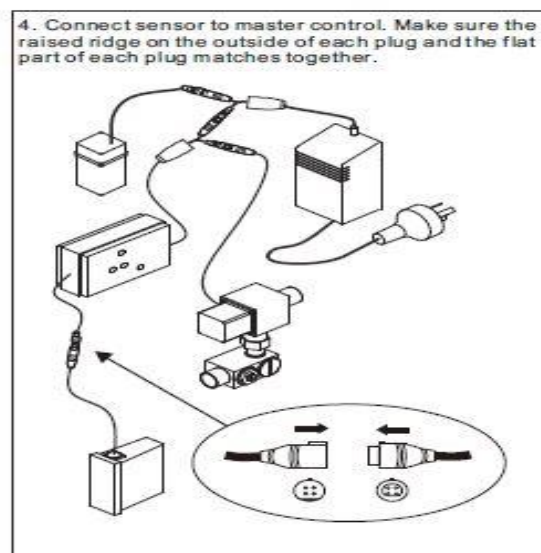
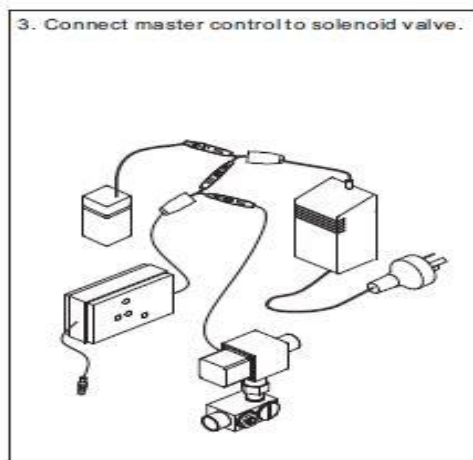
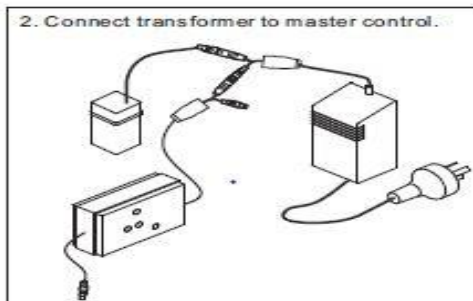
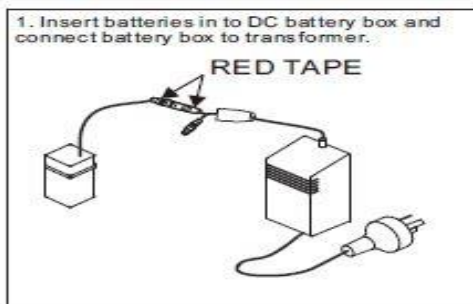

- THE FILTER OR SOLENOID IS BLOCKED – CLEAN AND RE-TEST;
- ENSURE UNIT HAS BEEN INSTALLED CORRECTLY, IN ACCORDANCE WITH THE INSTALLATION MANUAL;
- FLUSH VALVE IS URINE SENSING. IT DOES NOT DETECT MOVEMENT IN THE ROOM, HEAT, LIGHT OR ANY OTHER METHOD OF ACTIVATION - PERFORM CONNECTION AND SENSOR TESTS;

Connection Test - this will confirm if controller is working correctly. It will confirm that there is power and that the connections are correct - Unplug sensor cable and rub thumb over the 4 metal pins. The red light on the controller will start to flash. Stop rubbing the pins when the red light stops flashing (up to 20 seconds). The solenoid will be activated and the urinal will flush.

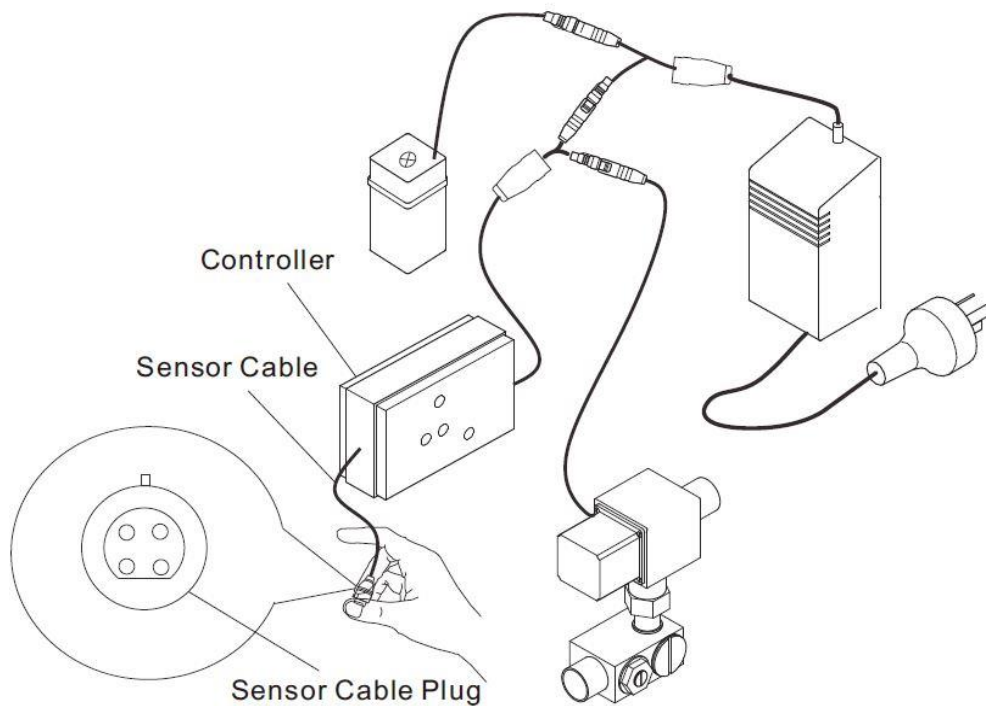

Sensor Test – This will confirm that the sensor has been installed correctly. Make sure silicone is dry before performing flush test - Pour water slowly over the surface of the urinal (must run over sensor location). If the red light on the controller is flashing, when you stop pouring water the red light will stay on - there will be a delay but the urinal will flush.

If no lights on controller or unit does not flush, check that sensor has been installed correctly and that the silicone has not spread to sensing surface, see drawing below.

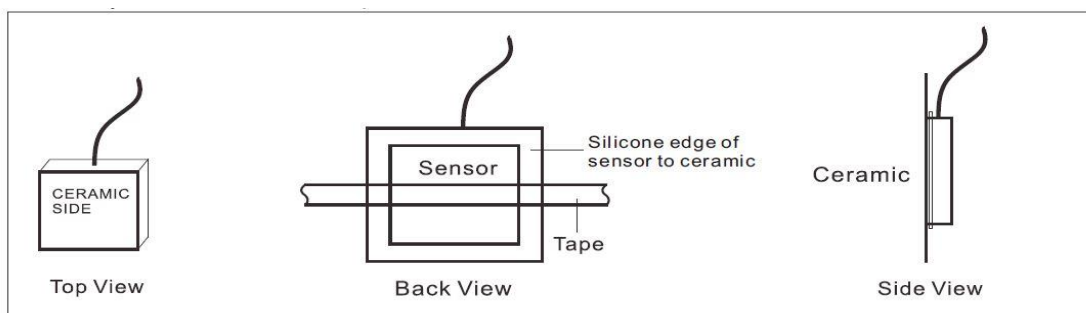

Issue – Not Enough or Too Much Water Flow

- CHECK AND ADJUST YOUR WATER PRESSURE AS APPROPRIATE – RECOMMENDED MINIMUM PRESSURE IS 350kPA;
- THE FILTER/SOLENOID MAY BE BLOCKED, CLEAN AND RE-TEST;
- FLOW VALVE MAY REQUIRE ADJUSTMENT – FLOW CAN BE ADJUSTED WITH FLOW VALVE SCREW ON SOLENOID VALVE, NEXT TO THE INLET – SEE DIAGRAM:

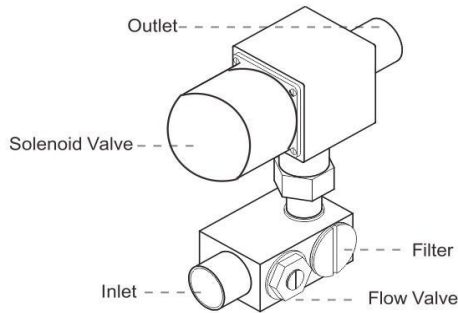

Issue – Flush Time/Sensing Distance Not Adequate

- FLUSH VALVE SETTINGS MAY REQUIRE SET-UP/ADJUSTMENT (SEE DIAGRAMS BELOW)

EXTERNAL VIEW

Carefully remove front cover by inserting small flat edge screwdriver into hole on the side of the controller.

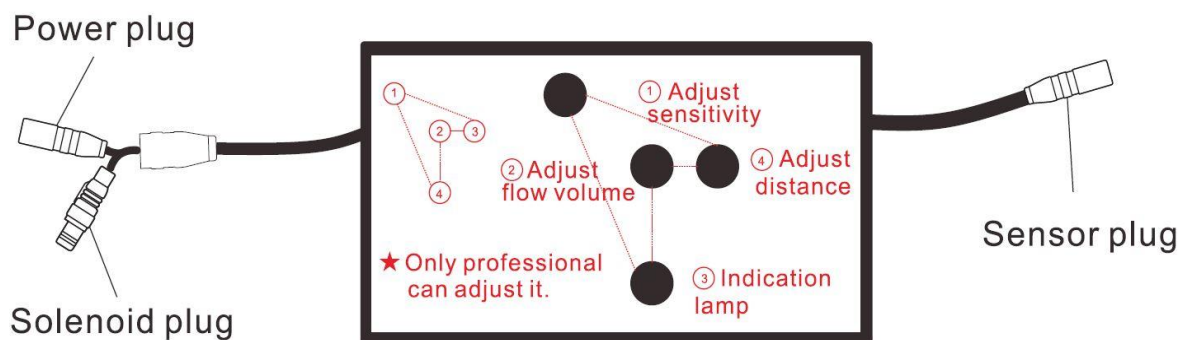

INTERNAL VIEW

Any adjustments should only be made using a small cross head screwdriver and gentle ¼ turns. Excessive force will cause the grub screw to snap.

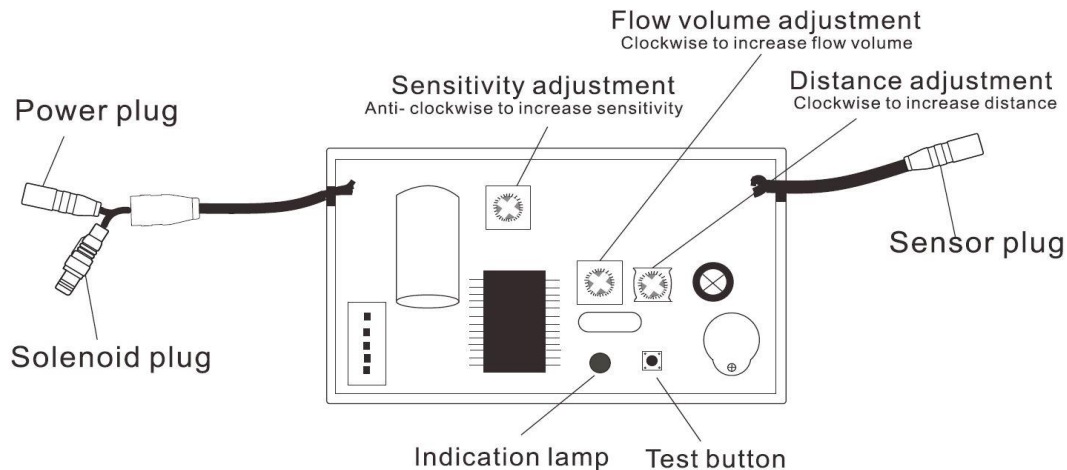

Sensitivity – this makes an adjustment to the sensitivity of the sensor. Effectiveness of sensor can be compromised if too much silicone is used on install or the sensor is not installed in the correct area. Increasing the sensitivity and/or sensor distance may help.

Distance – this increases the distance at which the sensor can activate (detection zone). Effectiveness of sensor can be compromised if too much silicone is used on install or the sensor is not installed in the correct area. Increasing the sensor distance and/or sensitivity may help.

Flow Volume – this increases the length of time of the flush. Controlling how long the solenoid is 'open' for allows more water to pass through the solenoid during the flush activation. NB. Adjustments to increase water flow volume should usually be made on the flow adjuster valve on the solenoid. (Any adjustments may reduce the WELS rating)

Issue – Self-Activation (Second Flush)

- CHECK INSTALLED IN ACCORDANCE WITH INSTALLATION MANUAL – VALVE MUST BE INSTALLED DIRECTLY ABOVE URINAL WITH SINGLE STRAIGHT COPPER PIPE BETWEEN SOLENOID AND URINAL, ENSURE NO BENDS OR KINKS. **IMPORTANT – ANY BENDS/KINKS OR HORIZONTAL PIECES OF PIPEWORK, WILL RESULT IN RESIDUAL WATER RUNNING OUT OVER THE SENSOR ACTIVATION ZONE CAUSING REACTIVATION ONCE CONFIRMATION TIME IS COMPLETE.**
- REDUCING SENSITIVITY AND/OR DISTANCE OF SENSOR ON THE CONTROLLER MAY MITIGATE THIS ISSUE. (SEE DIAGRAMS ABOVE). IF RUN ON PERSISTS, YOU MAY NEED TO CONSIDER INSTALLING AN AIR GAP.

For further information and advice - contact us on:
1300 530 883 or e-mail info@enviro-tech.com.au